

Article number: 03506140

Description: Fluro Rod end GE 140FO-2RS

Measures

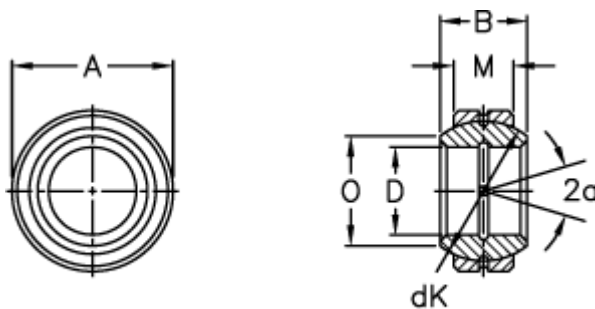

Str. 6-12 uden smørerille

A = 230 0 -0,030

B = 130

D = 140 0 -0,025

dK = 200

Dynamic load C (kN) = 1370

M = 80

O = 151.9

Static load C0 (kN) = 6800

Tilt angle = 16

Weight = 18800